

## **ELEMENTI MODULARI DI STAFFAGGIO** **MODULAR CLAMPING ELEMENTS**











## SIMBOLOGIA DATI TECNICI

## TECHNICAL DATA ICONS

ELEMENTI MODUULARI DI STAFFAGGIO MODULAR CLAMPING TOOLS						 <p>Kit staffaggi Clamping kit</p>
BULLONERIA VARIA NUTS AND BOLTS						 <p>Bulloneria varia Nuts and bolts</p>
POSSIBILITÀ DI POSSIBILITY OF						 <p>Staffe intelligenti Intelligent clamps</p>
PAGINE PAGES					 <p>Accessori &amp; Ricambi Accessories &amp; Spare Parts</p>	 <p>Istruzioni corretto utilizzo Instruction for a proper use</p>

Dimensioni mm / Dimensions mm	A	B	C	D	H min	H max	gr	Cod.
<b>Art. S110</b>	31.5	22	30	38	31,5	53	90	S110.00001
	64.5	36.5	30	70	64,5	105	300	S110.00002
	128	68	30	132	128	208	1050	S.110.00003

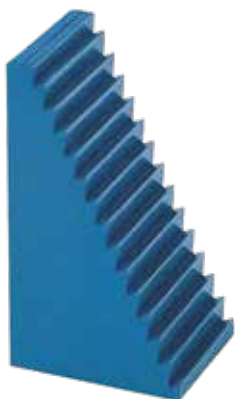
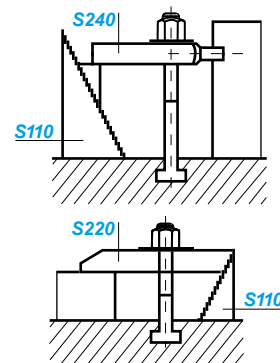
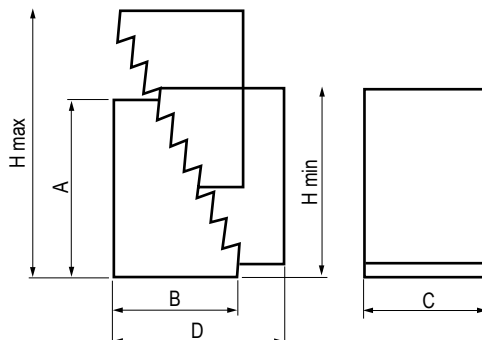
 Appoggi dentati  
Toothed supports

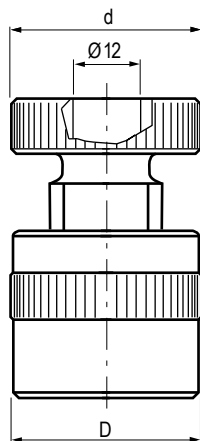
 Altezza gradino: verticale = 4,65 mm / Orizzontale = 2,3 mm  
 Height of tooth: vertical = 4,65 mm / horizontal = 2,3 mm

**Art. S120**

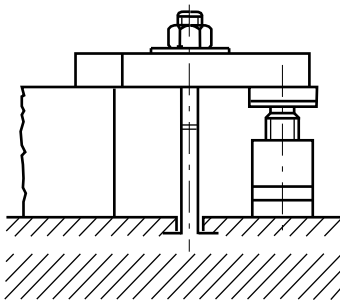
 Appoggi a vite  
Screw supports

H min	H max	d	D	kN	gr	Passo	Cod.
38	50	34	34	20	190	M30	S120.00050
50	70	50	50	60	620	M30	S120.00070
70	100	50	50	60	900	M30	S120.00100
100	140	65	70	105	2600	Q 40 x 6	S120.00140
140	210	70	80	180	4900	Q 40 x 6	S120.00210
190	300	80	100	360	10500	Q 40 x 6	S120.00300

**Art. S121**

 Appoggi a vite con base in alluminio  
Screw supports with aluminium base

h min	H max	d	D	kN	gr	Cod.
42	52	50	50	30	370	S121.00050
60	72	50	50	30	380	S121.00070
70	100	50	50	30	600	S121.00100

**Art. S122**

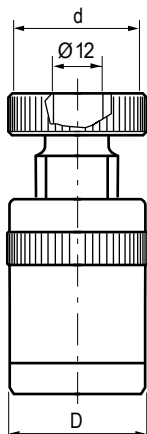
 Appoggi a vite con base magnetica  
Screw supports with magnetic base

h min	H max	d	D	kN	gr	Cod.
57	64	50	50	30	380	S122.00050
75	84	50	50	30	550	S122.00070
85	112	50	50	30	710	S122.00100

 Possibilità di posizionamento e registrazione sia in orizzontale che in verticale  
 Possibilità di posizionamento e registrazione sia in orizzontale che in verticale

 Base-materiale Art. S121 e S122: lega in alluminio ERGAL (EN 7075 UNI 3735)  
 Base-material Art. S121 and S122: ERGAL aluminium alloy (EN 7075 UNI 3735)

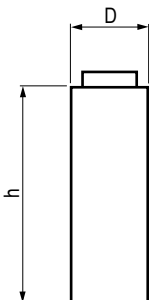
Dimensioni mm / Dimensions mm		D	h	per Articolo	gr	Cod.	
<b>Art. S125</b>							
Prolungha per appoggi a vite Extension pieces for screw supports							
							
		35	25	S120.00050	25	S125.35025	
		35	50	"	50	S125.35050	
		35	75	"	75	S125.35075	
		35	100	"	100	S125.35100	
		50	50	S120.00070 / 100	50	S125.50050	
		50	75	"	75	S125.50075	
		50	100	"	100	S125.50100	
		50	150	"	150	S125.50150	
		70	50	S120.00140	50	S125.70050	
		70	100	"	100	S125.70100	
		70	150	"	150	S125.70150	
		70	200	"	200	S125.70200	

Utilizzato con l'Art. S120 permette di prolungare l'altezza dell'appoggio. Possono essere sovrapposte.

Used with S120 give possibility to extend the length of the support. They should be placed one upon another

### Art. S130

Appoggi a vite ATLAS  
Screw supports ATLAS type



h min	H max	A	D	kN	gr	Cod.	
100	140	18	50	60	1800	S130.18140	
140	200	18	50	60	2300	S130.18200	
200	320	22	50	40	3600	S130.22320	
320	550	22	50	25	5500	S130.22550	

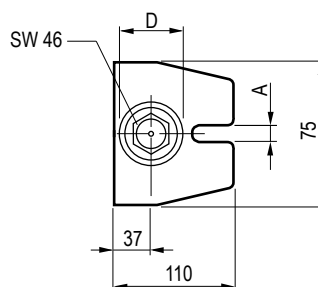

Filettatura trapezoidale passo 30 x 6. Con vite di fermo  
Trapezoidal thread 30 x 6. With stationary screw

### Art. S131

Appoggi a vite tipo pesante  
Screw bearing type heavy



h min	H max	A	D	kN	gr	Cod.	
200	300	26	70	80	9500	S131.00300	
280	460	26	70	60	11000	S131.00460	
430	750	26	70	50	13500	S131.00750	
710	1250	26	70	45	19000	S131.01250	

Filettatura trapezoidale passo 40 x 6  
Trapezoidal thread 40 x 6

Dimensioni mm / Dimensions mm		A	B	C	D	E	F	G	H	L		gr	Cod.	
<b>Art. S210</b>	Staffe semplici Standard clamps	10	20	7	20	10	8			50	6	65	S210.07050	
		12	25	9	22	13	10			60	8	115	S210.09060	
		15	30	11	30	15	12			80	10	225	S210.11080	
		20	40	14	40	21	14			100	12-14	500	S210.14100	
		20	40	14	50	21	14			125	12-14	620	S210.14125	
		20	40	14	65	21	14			160	12-14	815	S210.14160	
		25	50	18	45	26	18			125	16-18	980	S210.18125	
		25	50	18	65	26	18			160	16-18	1260	S210.18160	
		25	50	18	80	26	18			200	16-18	1600	S210.18200	
		30	60	22	60	30	22			160	20-22	1850	S210.22160	
		30	60	22	80	30	22			200	20-22	2300	S210.22200	
		30	70	26	80	35	26			200	24	2650	S210.26200	
		30	70	26	105	35	26			250	24	3300	S210.26250	
		40	80	34	100	45	34			250	27-30	5000	S210.34250	
		40	80	34	130	45	34			315	27-30	6200	S210.34315	

**Art. S211**  
Staffe semplici ridotte  
Shaped standard clamps  
**R. > 700 N / mm<sup>2</sup>**

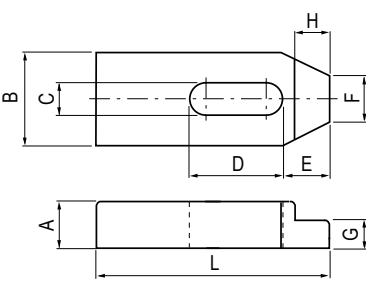

10	20	7	20	10	8	6	7	50	6	60	S211.07050
12	25	9	22	13	10	7	10	60	8	140	S211.09060
15	30	11	30	15	12	9	9	80	10	220	S211.11080
20	40	14	40	21	14	12	12	100	12-14	480	S211.14100
20	40	14	50	21	14	12	12	125	12-14	615	S211.14125
20	40	14	65	26	14	12	12	160	12-14	800	S211.14160
25	50	18	45	26	18	15	15	125	16-18	960	S211.18125
25	50	18	65	26	18	15	15	160	16-18	1230	S211.18160
25	50	18	80	26	18	15	15	200	16-18	1550	S211.18200
30	60	22	60	30	22	20	20	160	20-22	1800	S211.22160
30	60	22	80	30	22	20	20	200	20-22	2200	S211.22200
30	70	26	80	35	26	20	25	200	24	2450	S211.26200
30	70	26	105	35	26	20	25	250	24	3200	S211.26250
40	80	34	100	45	34	25	25	250	27-30	4800	S211.34250
40	80	34	130	45	34	25	25	315	27-30	6000	S211.34315

**Art. S220**  
Staffe dentate  
Toothed clamps  
**R. > 700 N / mm<sup>2</sup>**

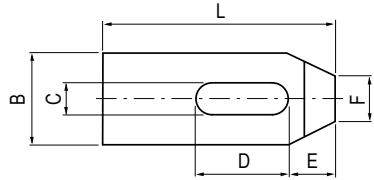

10	20	7	20	10	8	6		50	6	55	S220.07050
12	25	9	22	13	10	8		60	8	125	S220.09060
15	30	11	30	15	12	10		80	10	205	S220.11080
20	40	14	40	21	14	12		100	12-14	445	S220.14100
25	50	18	45	26	18	15		125	16-18	930	S220.18125
30	60	22	60	30	22	18		160	20-22	1700	S220.22160
30	70	26	80	35	26	18		200	24	2500	S220.26200

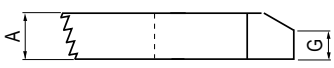

**Art. S230**  
Staffe regolabili con vite a passo fine  
Adjustable clamps with fine pitch screw  
**R. > 700 N / mm<sup>2</sup>**

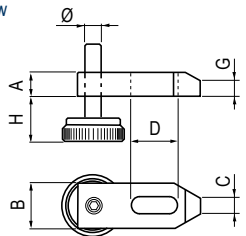

A	B	C	D	G	H	L	Ø		gr	Cod.	
15	30	11	30	10	8-28	80	M10	10	345	S.230.11080	
20	40	14	40	12	10-32	100	M12	12-14	680	S.230.14100	
25	50	18	45	15	13-40	125	M16	16-18	1185	S.230.18125	
30	60	22	60	18	18-60	160	M20	20-22	2030	S.230.22160	

**Art. S231**  
Viti di ricambio  
Spare screws

Viti ricambio / Spare screws		A	B	H	L	gr	Cod.	
<b>Art. S231</b>		40	M10	8	60	130	S231.00010	
		45	M12	8	60	210	S231.00012	
		45	M16	8	70	245	S231.00016	
		45	M20	8	80	300	S231.00020	

Dimensioni mm / Dimensions mm		A	B	C	D	E	F	G	H	L		gr	Cod.
<b>Art. S240</b> Staffe a forcella con gambo cilindrico Forked clamps with cylindrical shank  <i>R. &gt; 600 N / mm<sup>2</sup></i>		15	30	9	30	18	12			100	8	205	S240.09100
		20	30	11	36	24	16			125	10	335	S240.11125
		25	40	14	45	30	20			160	12-14	720	S240.14160
		25	40	14	45	30	20			200	12-14	920	S240.14200
		30	50	18	55	36	24			200	16-18	1310	S240.18200
		30	50	18	55	36	24			250	16-18	1640	S240.18250
		40	60	22	65	45	30			250	20-22	2160	S240.22250
		40	60	22	65	45	30			315	20-22	3300	S240.22315
		40	70	26	80	56	38			250	24	3100	S240.26250
		40	70	26	80	56	38			315	24	3900	S240.26315
		50	80	34	85	56	45			315	27-30	5500	S240.34315
		50	80	34	85	56	45			400	27-30	6900	S240.34400

<b>Art. S250</b> Staffe a forcella con nasello Forket clamps with nib  <i>R. &gt; 600 N / mm<sup>2</sup></i>		15	30	9	30	18	16	5		100	8	225	S250.09100
		20	30	11	36	24	20	6		125	10	360	S250.11125
		25	40	14	45	30	25	7		160	12-14	770	S250.14160
		25	40	14	45	30	25	7		200	12-14	950	S250.14200
		30	50	18	55	36	28	8		200	16-18	1420	S250.18200
		30	50	18	55	36	28	8		250	16-18	1700	S250.18250
		40	60	22	65	45	35	10		250	20-22	2790	S250.22250
		40	60	22	65	45	35	10		315	20-22	3480	S250.22315
		40	70	26	80	56	43	10		250	24	3320	S250.26250
		40	70	26	80	56	43	10		315	24	4270	S250.26315
		50	80	34	85	56	50	12		315	27-30	5700	S250.34315
		50	80	34	85	56	50	12		400	27-30	7250	S250.34400

<b>Art. S260</b> Staffe a gomito Cranked clamps  <i>R. &gt; 700 N / mm<sup>2</sup></i>		40	20	30	20	14	20	23	40	125	12-14	750	S260.14125
		50	25	40	25	18	25	28	50	160	16-18	1510	S260.18160
		50	25	60	25	18	25	28	50	200	16-18	1790	S260.18200
		60	30	40	30	22	30	35	60	160	20-22	2190	S260.22160
		60	30	60	30	22	30	35	60	200	20-22	2700	S260.22200
		70	35	50	35	26	35	38	70	200	24	3660	S260.26200
		70	35	75	35	26	35	38	70	250	24	4560	S260.26250

Il pregio dell'articolo sta nell'essere prodotto tramite la fresatura di un blocco d'acciaio (non è quindi piegato)  
This article is produced milling a steel block (it is not produced by bending)

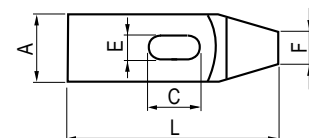
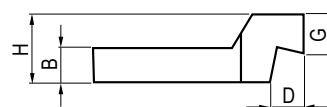

Dimensioni mm / Dimensions mm	A	B	C	G	L		gr	Cod.	
<b>Art. S270</b>									
Staffe a forcella con smusso Forked clamps with bevel									
<b>R. &gt; 600 N / mm<sup>2</sup></b>									
Il pregio dell'articolo sta nell'essere prodotto tramite la fresatura di un blocco d'acciaio (non è quindi piegato) This article is produced milling a steel block (it is not produced by bending)									
	12	20	7	3	60	6	70	S270.07060	
	15	25	9	4	80	8	150	S270.09080	
	20	30	11	5	100	10	270	S270.11100	
	25	40	14	6	125	12-14	590	S270.14125	
	25	40	14	6	160	12-14	760	S270.14160	
	25	40	14	6	200	12-14	970	S270.14200	
	30	50	18	8	160	16-18	1160	S270.18160	
	30	50	18	8	200	16-18	1400	S270.18200	
	40	50	18	10	250	16-18	2330	S270.18250	
	40	50	22	10	200	20-22	1700	S270.22200	
	40	60	22	10	250	20-22	2880	S270.22250	
	40	60	22	10	315	20-22	2530	S270.22315	
	40	70	26	10	200	24	2680	S270.26200	
	40	70	26	10	250	24	3370	S270.26250	
	40	70	26	10	315	24	4220	S270.26315	
	50	80	34	12	250	27-30	4480	S270.34250	
	50	80	34	12	315	27-30	5600	S270.34315	
	50	80	34	12	400	27-30	7150	S270.34400	
	60	100	40	12	400	36	11700	S270.40400	
	60	100	40	12	600	36	17300	S270.40600	

Dimensioni mm / Dimensions mm	A	B	C	D	E	F	H	L	Ø		gr	Cod.	
<b>Art. S280</b>													
Staffe regolabili con vite a passo quadro Adjustable clamps with square thread screw													
<b>R. &gt; 700 N / mm<sup>2</sup></b>													
	20	40	15	40	12	12	15-50	100	20x4	12-14	620	S280.14100	
	20	40	15	45	12	12	15-50	125	20x4	12-14	770	S280.14125	
	20	40	15	60	12	12	15-50	160	20x4	12-14	950	S280.14160	
	25	50	19	45	15	15	15-70	125	20x4	16-18	1090	S280.18125	
	25	50	19	60	15	15	15-70	160	30x6	16-18	1640	S280.18160	
	25	50	19	80	15	15	15-70	200	30x6	16-18	1970	S280.18200	
	30	60	23	60	15	20	15-70	160	30x6	20-22	2120	S280.22160	
	30	60	23	80	15	20	15-70	200	30x6	20-22	2570	S280.22200	
	40	70	27	80	25	23	15-70	200	30x6	24	3700	S280.26200	
	40	70	27	100	25	23	15-70	250	30x6	24	4620	S280.26250	
	40	70	27	100	25	23	15-70	300	30x6	24	5740	S280.26300	

Dimensioni mm / Dimensions mm	A	B	H	L	gr	Cod.	
<b>Art. S281</b>							
Viti di ricambio per staffe Spare screw for clamps							
	10	20 x 4	70	35	190	S281.20004	
	15	30 x 6	100	45	540	S281.30006	
	15	30 x 6	125	70	1050	S281.30006.A	

Filetto TPN passo quadro.  
Materiale: 35SMnPb 10 UNI 4838. Classe 8.8  
TPN thread square pitch.  
Material: SMnPb 10 UNI 4838. Class 8.8



Dimensioni mm / Dimensions mm		A	B	C	D	d	gr	Cod.
<b>Art. S151</b>		18	37	8	35	12	70	S151.00035
Puntali bombati Convex caps								
Utilizzati su Art. S120, S121, S122, S130, S131 Used on Art. S120, S121, S122, S130, S131								

<b>Art. S152</b>		23	32	8	45	12	145	S152.00045
Puntali prismatici "V" groove caps								
Utilizzati su Art. S120, S121, S122, S130, S131 Used on Art. S120, S121, S122, S130, S131								
		38	56	8	65	12	580	S152.00065

Dimensioni mm / Dimensions mm		A	B	C	D		kN F1	kN F2	gr	Cod.
<b>Art. ML10</b>		80	40	20	11,7	12	16	0,6	1040	ML10.00012
Morsetti laterali Side buckles										
Costruzione a cuneo che permette il bloccaggio contemporaneo del pezzo in senso verticale e orizzontale Forniti in coppia Wesge type construction which enable to simultaneously clamp vertically and horizontally. Supplied in pairs										
		80	40	20	13,7	14	22	0,9	1070	ML10.00014
		100	50	25	15,7	16	32	1,2	2040	ML10.00016
		100	50	25	17,7	18	36	1,4	2080	ML10.00018
		100	50	25	19,7	20	36	1,4	2290	ML10.00020
		140	78	30	21,7	22	36	1,4	5530	ML10.00022
		140	78	30	23,7	24	36	1,4	5800	ML10.00024
		140	78	30	27,7	28	40	1,6	6200	ML10.00028
		140	78	30	29,7	30	40	1,6	6800	ML10.00030

## STAFFAGGI ASSORTITI ASSORTED CLAMPING TOOLS

### Art. S410

Kit 46 pezzi / pcs.



### Art. S440

Kit 20 pezzi / pcs.

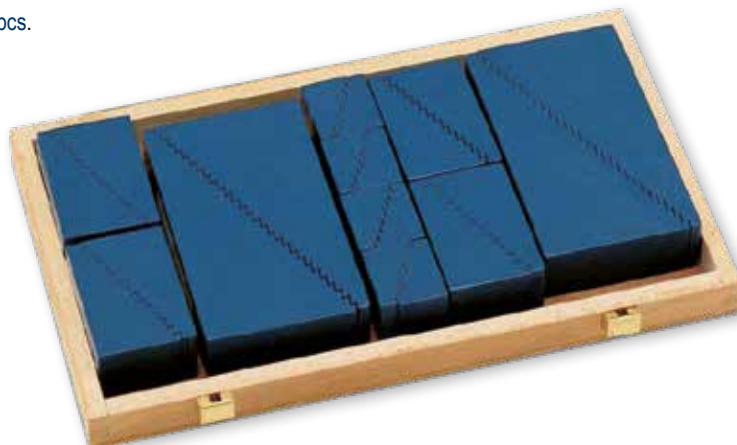

# APPOGGI DENTATI MULTIPLE STEP SUPPORT

**Art. S410**

Kit 46 pezzi / pcs.

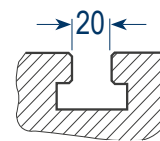
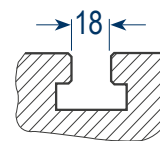
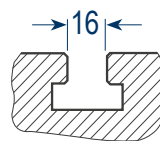
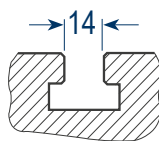
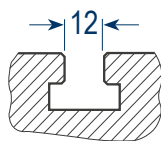

Descrizione contenuto Contents description	Cod. S410.00012	Cod. S410.00014	Cod. S410.00016	Cod. S410.00018	Cod. S410.00020
Appoggi dentati / Toothed support	n. 2 S110.00001	n. 2 S110.00001	n. 2 S110.00001	n. 2 S110.00001	n. 2 S110.00001
Appoggi dentati / Toothed support	n. 4 S110.00002	n. 4 S110.00002	n. 4 S110.00002	n. 4 S110.00002	n. 4 S110.00002
Appoggi dentati / Toothed support	n. 2 S110.00003	n. 2 S110.00003	n. 2 S110.00003	n. 2 S110.00003	n. 2 S110.00003
Staffe semplici / Flat clamps	n. 4 S210.14100	n. 4 S210.14125	n. 4 S210.14100	n. 4 S210.18125	n. 4 S210.22200
Staffe dentate / Toothed clamps	n. 4 S220.14100	n. 4 S220.14100	n. 4 S220.18125	n. 4 S220.18125	n. 4 S220.22160
Viti testa martello / T-slot bolts	n. 2 S310.12080	n. 2 S310.14100	n. 4 S310.16100	n. 4 S310.18150	n. 4 S310.20150
Viti testa martello / T-slot bolts	n. 4 S310.12125	n. 4 S310.14150	n. 2 S310.16150	n. 2 S310.18200	n. 2 S310.20200
Prigionieri completi / Studs	n. 2 S320.10080	n. 2 S320.12080	n. 2 S320.14100	n. 2 S320.16125	n. 2 S320.18125
Prigionieri completi / Studs	n. 2 S320.10100	n. 2 S320.12160	n. 2 S320.14160	n. 2 S320.16160	n. 2 S320.18160
Dadi prolung. / Extensions nuts	n. 4 S350.10030	n. 4 S350.12036	n. 4 S350.14042	n. 4 S350.16048	n. 4 S350.18054
Dadi altri / Turned toll nuts	n. 6 S340.12018	n. 6 S340.14021	n. 6 S340.16024	n. 6 S340.18027	n. 6 S340.20030
Tasselli per cave / T-slot nuts	n. 4 S360.10012	n. 4 S360.12014	n. 4 S360.14016	n. 4 S360.16018	n. 4 S360.18020
Rondelle / Washers	n. 6 S370.00012	n. 6 S370.00014	n. 6 S370.00016	n. 6 S370.00018	n. 6 S370.00020
Peso kg / Weight kg	10,5	12	17	18	27
Dimensioni cm / Dimensions cm	37 x 32		47 x 33		50 x 41
Cassetta in legno vuota Wooden box	Cod. S410.BOX01		Cod. S410.BOX02		Cod. S410.BOX03

**Art. S440**

Kit 20 pezzi / pcs.

 Descrizione contenuto  
Contents description



S110.00001	8 pezzi / pcs
S110.00002	8 pezzi / pcs
S110.00003	4 pezzi / pcs
Peso kg / Weight kg	8,5
Dimensioni cm / Dimensions cm	30,5 x 17

Cod. S440.00001

# ELEMENTI MODULARI DI STAFFAGGIO Materiale: Alluminio

## MODULAR CLAMPING TOOLS Material: Aluminum

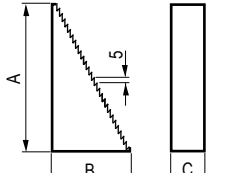
**STAFFAGGI ASSORTITI IN ALLUMINIO - ALUMINIUM ASSORTED CLAMPING TOOLS**

Dimensioni mm / Dimensions mm	A	B	C	D	E	F	G	L	gr	Cod.
<b>Art. S115</b> Appoggi dentati / Toothed supports	34	28	25						35	S115.00001
	66	38	25						100	S115.00002
	128	70	25						280	S115.00003

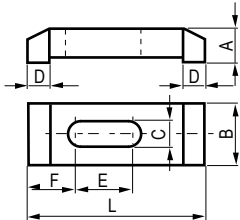
Dimensioni mm / Dimensions mm	A	B	C	D	E	F	G	L	gr	Cod.
<b>Art. S215</b> Staffe doppie / Double clamps	15	25	9	11	28	20		65	40	S215.00065
	20	25	9	14	40	20		100	85	S215.00100
	20	30	9	18	65	24		150	150	S215.00150

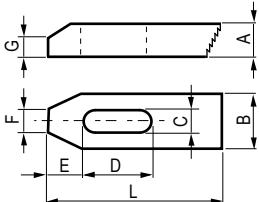
Dimensioni mm / Dimensions mm	A	B	C	D	E	F	G	L	gr	Cod.
<b>Art. S225</b> Staffe dentate / Toothed clamps	13	25	9	25	16	10	11	65	43	S225.00065
	17	25	9	46	20	11	11	100	92	S225.00100
	17	30	9	82	23	12	12	150	162	S225.00150

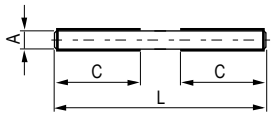
Dimensioni mm / Dimensions mm	A	B	C	D	E	F	G	L	gr	Cod.
<b>Art. S325</b> Prigionieri singoli in acciaio zincato Single studs in zinked steel	M8		40					100	31	S325.08100
	M8		40					125	39	S325.08125
	M8		40					150	47	S325.08150
	M8		40					175	54	S325.08175
	M8		40					200	62	S325.08200

# BULLONERIA VARIA Materiale: UNI 42CrMo4 a norma ASTM A193-B7 Classe 10.9

## NUTS AND BOLTS Material: UNI 42CrMe4 according to standard ASTM A193 B7 Class 10.9

Dimensioni mm / Dimensions mm	A	B	D	H	L	T	gr	Cod.	
<b>Art. S310</b>									
Vite testa martello completa di dado S340 e rondella S370 Hammerheads bolts complete with nut S340 and washer S370									
Filetto ottenuto per rollatura / Rolled thread									
	11,7	55	M12	7	80	18	125	S310.12080	
	11,7	75	M12	7	125	18	150	S310.12125	
	13,7	65	M14	8	100	22	215	S310.14100	
	13,7	100	M14	8	150	22	270	S310.14150	
	15,7	63	M16	9	100	25	270	S310.16100	
	15,7	100	M16	9	150	25	345	S310.16150	
	17,7	100	M18	10	150	28	450	S310.18150	
	17,7	125	M18	10	200	28	530	S310.18200	
	19,7	100	M20	12	150	32	600	S310.20150	
	19,7	125	M20	12	200	32	700	S310.20200	

<b>Art. S320</b>									
Prigionieri completi di dado S330 e rondella S370 Studs complete with short nut S330 and washer S370									
Filetto ottenuto per rollatura / Rolled thread									
	13	50	M10		80		65	S320.10080	
	13	75	M10		100		75	S320.10100	
	15	50	M12		80		95	S320.12080	
	15	100	M12		160		155	S320.12160	
	17	63	M14		100		160	S320.14100	
	17	100	M14		160		215	S320.14160	
	19	75	M16		125		235	S320.16125	
	19	100	M16		160		295	S320.16160	
	23	75	M18		125		300	S320.18125	
	23	100	M18		160		355	S320.18160	

<b>Art. S321</b>									
Prigionieri singoli Single studs									
Filetto ottenuto per rollatura / Rolled thread									
	14	25	M10		60		30	S321.10060	
	14	30	M10		80		40	S321.10080	
	14	35	M10		100		50	S321.10100	
	14	40	M10		120		65	S321.10120	
	14	50	M10		160		80	S321.10160	
	14	60	M10		200		100	S321.10200	
	15	32	M12		60		45	S321.12060	
	15	50	M12		80		55	S321.12080	
	15	63	M12		100		70	S321.12100	
	15	75	M12		125		90	S321.12125	
	15	100	M12		160		115	S321.12160	
	15	125	M12		200		140	S321.12200	
	19	35	M16		65		85	S321.16065	
	19	50	M16		80		105	S321.16080	
	19	75	M16		125		160	S321.16125	
	19	100	M16		160		220	S321.16160	
	19	125	M16		200		280	S321.16200	
	19	160	M16		250		325	S321.16250	

! Si eseguono su richiesta misure non a catalogo / Other sizes can be supplied on request

# BULLONERIA VARIA Material: UNI 42CrMo4 according a norma ASTM A193-B7 Classe 10.9

## NUTS AND BOLTS Material: UNI 42CrMo4 according to standard ASTM A193-B7 Class 10.9

**DADI e RONDELLE - NUTS and WASHERS**

Dimensioni mm / Dimensions mm	A	B	C	D	E	H	M	S	T	gr		Cod.
<b>Art. S340</b> Dadi alti torniti - Turned tall nuts 					21,5	18	M12	19		28		S340.12018
					25	21	M14	22		45		S340.14021
					27,5	24	M16	24		58		S340.16024
					31	27	M18	27		83		S340.18027
					34,6	30	M20	30		110		S340.20030
<b>Art. S350</b> Ex. Art. S360 Dadi prolungamento - Extension nuts 					19,6	30	M10	17		42		S350.10030
					21,5	36	M12	19		64		S350.12036
					25	42	M14	22		95		S350.14042
					27,5	48	M16	24		120		S350.16048
					31	54	M18	27		170		S350.18054
<b>Art. 287</b> Dadi per cave a "T" - Nuts for "T" slots 	18	14	7	11,7			M10			12	12	2.28.72000 / 12
	22	16	8	13,7			M12			22	14	2.28.72000 / 19
	25	18	9	15,7			M14			37	16	2.28.740000 / 27
	28	20	10	17,7			M16			59	18	2.28.740000 / 32
	32	24	12	19,7			M18			82	20	2.28.760000 / 39
<b>Art. S370</b> Rondelle normali tornite - Flat washer 					10,5	22	4			9		S370.00010
					13	28	5			20		S370.00012
					15	35	6			35		S370.00014
					17	35	6			35		S370.00016
					19	40	6			45		S370.00018
<b>Art. S380</b> Rondelle alte tornite - Thick washer 					10,5	35	8			55		S380.00010
					13	40	8			70		S380.00012
					15	40	10			85		S380.00014
					17	45	10			105		S380.00016
					19	45	10			100		S380.00018

! Si eseguono su richiesta misure non a catalogo / Other sizes can be supplied on request

# ELEMENTI MODULARI DI STAFFAGGIO Materiale: Acciaio da bonifica verniciato

## MODULAR CLAMPING TOOLS Material: Hardened painted steel

### KIT STAFFAGGI DA 58 PEZZI - CLAMPING KIT / 58 PIECES

Con appoggi dentati e staffe dentate - With step bloks & stepped strap clamping

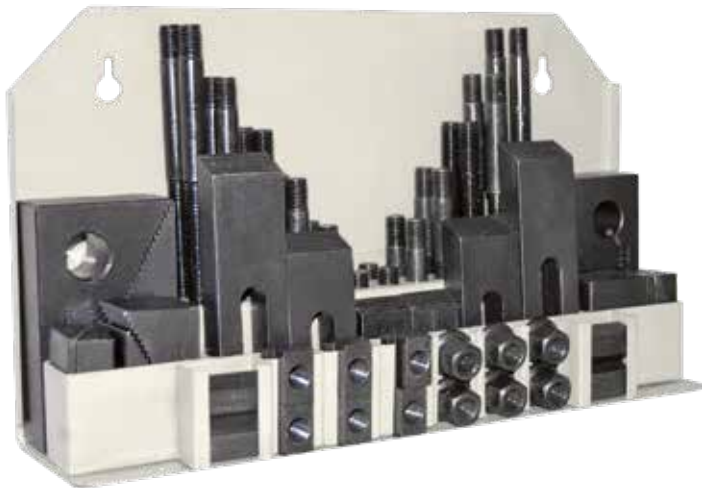







Ciascun kit include tutti i più importanti elementi di staffaggio per serrare una varietà di particolari. La tabella sottostante indica il contenuto di ogni tipologia di kit di staffaggi adatta per differenti dimensioni di cave a "T"

Each kit consists of all important clamping elements required to clamp a variety of work pieces. Following table shows the contents of each model of clamping kit suitable for different T-Slot sizes.

#### Art. G410

Il Clamping Kit **GERARDI** da 58 pezzi è disponibile in una elegante rastrelliera che può essere appesa alle macchine o su una parete o appoggiata ad un banco.

**GERARDI** Clamping Kit - 58 pieces is available in an attractive powder coated metallic rack which can be hung on machines or a wall or kept on a table.

Descrizione prodotto Product Description	Cod.	G410.581210	G410.581410	G410.581412	G410.581612	G410.581812	G410.581816	G410.582016	G410.582216
		T-SLOT SIZE 12mm	T-SLOT SIZE 14mm	T-SLOT SIZE 14mm	T-SLOT SIZE 16mm	T-SLOT SIZE 18mm	T-SLOT SIZE 18mm	T-SLOT SIZE 20mm	T-SLOT SIZE 22mm
 Dadi a T T nuts (6 pcs)		TN-12-M10	TN-14-M10	TN-14-M12	TN-16-M12	TN-18-M12	TN-18-M16	TN-20-M16	TN-22-M16
 Prigionieri Clamping studs (4 pcs)		CS-10-75 CS-10-100 CS-10-125 CS-10-150 CS-10-175 CS-10-200	CS-10-75 CS-10-100 CS-10-125 CS-10-150 CS-10-175 CS-10-200	CS-12-75 CS-12-100 CS-12-125 CS-12-150 CS-12-175 CS-12-200	CS-12-75 CS-12-100 CS-12-125 CS-12-150 CS-12-175 CS-12-200	CS-12-75 CS-12-100 CS-12-125 CS-12-150 CS-12-175 CS-12-200	CS-16-75 CS-16-100 CS-16-125 CS-16-150 CS-16-175 CS-16-200	CS-16-75 CS-16-100 CS-16-125 CS-16-150 CS-16-175 CS-16-200	CS-16-75 CS-16-100 CS-16-125 CS-16-150 CS-16-175 CS-16-200
 Dadi flangiati Flanged nuts (6 pcs)		FN-10	FN-10	FN-12	FN-12	FN-12	FN-16	FN-16	FN-16
 Dadi prolungamento Extension nuts (4 pcs)		EN-10	EN-10	EN-12	EN-12	EN-12	EN-16	EN-16	EN-16
 Staffe dentate Stepped strap clamps (2 pcs)		SSC-10-60 SSC-10-80 SSC-10-120	SSC-10-60 SSC-10-80 SSC-10-120	SSC-12-65 SSC-12-100 SSC-12-125	SSC-12-65 SSC-12-100 SSC-12-125	SSC-12-65 SSC-12-100 SSC-12-125	SSC-16-75 SSC-16-125 SSC-16-160	SSC-16-75 SSC-16-125 SSC-16-160	SSC-16-75 SSC-16-125 SSC-16-160
 Appoggi dentati Step blocks (4 pcs)		SB-1 SB-2 SB-3	SB-1 SB-2 SB-3	SB-1 SB-2 SB-3	SB-1 SB-2 SB-3	SB-1 SB-2 SB-3	SB-1 SB-2 SB-3	SB-1 SB-2 SB-3	SB-1 SB-2 SB-3
N° totale pezzi Total n. of pieces		58 pieces	58 pieces	58 pieces	58 pieces	58 pieces	58 pieces	58 pieces	58 pieces
Peso lordo totale Total gross weight		9 kg	9 kg	13 kg	13 kg	13 kg	18 kg	18,5 kg	19 kg

# ELEMENTI MODULARI DI STAFFAGGIO Materiale: Acciaio da bonifica verniciato

## MODULAR CLAMPING TOOLS Material: Hardened painted steel

**KIT STAFFAGGI DA 34 PEZZI - CLAMPING KIT / 34 PIECES**

**Con piastre di appoggio regolabili e piastre dentate - With adjustable support plates & strap clamps**

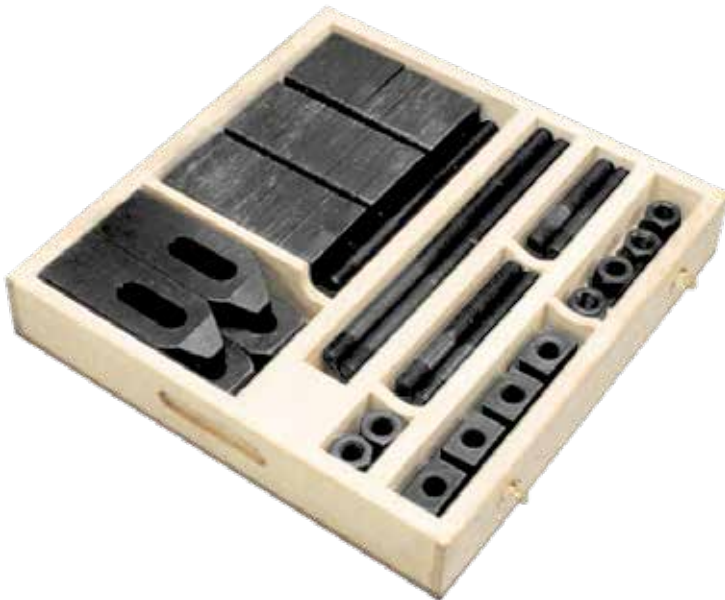





Il Clamping Kit **GERARDI** da 34 pezzi è un clamping kit economico alloggiato in una elegante scatola di legno.

**GERARDI** Clamping Kit - 34 pieces is an economical clamping kit housed in an elegant wooden box.

### Art.G411

La tabella sottostante indica il contenuto di ogni tipologia di kit di staffaggi adatta per different dimensioni di cave a "T"  
 Following table shows the contents of each model of clamping kit suitable for different T-Slot sizes.

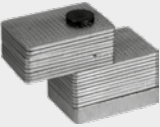
Descrizione Contenuto Contents Description		Cod.	G411.341412	G411.341612	G411.341812
			T-SLOT SIZE 14mm	T-SLOT SIZE 16mm	T-SLOT SIZE 18mm
	Dadi a T / T nuts (4 pcs)		TN14-M12	TN16-M12	TN18-M12
	Prigionieri Clamping studs (4 pcs)		CS-12-75 CS-12-100 CS-12-150 CS-12-200	CS-12-75 CS-12-100 CS-12-150 CS-12-200	CS-12-75 CS-12-100 CS-12-150 CS-16-200
	Dadi flangiati / Flanged nuts (2 pcs)		FN-12	FN-12	FN-12
	Dadi prolungamento / Extension nuts (2 pcs)		EN-12	EN-12	EN-12
	Staffe dentate Stepped strap clamps (2 pcs)		SSC-12-100 SSC-12-125	SSC-12-100 SSC-12-125	SSC-12-100 SSC-12-125
	Piastre di appoggio regolabili Adjustable support plates (2 pcs)		ASP-250 ASP-2100	ASP-250 ASP-2100	ASP-250 ASP-2100
N° totale pezzi / Total n. of pieces			<b>34 pieces</b>	<b>34 pieces</b>	<b>34 pieces</b>
Peso lordo totale / Total gross weight			-	-	-



**ELEMENTI MODULARI DI STAFFAGGIO** Materiale: Acciaio da bonifica verniciato

**MODULAR CLAMPING TOOLS** Material: Hardened painted steel

**VITI CALIBRATE - CALIBRATED SCREWS**

Dimensioni mm / Dimensions mm

**X = mm**
**gr**

Cod.

**Art.83**

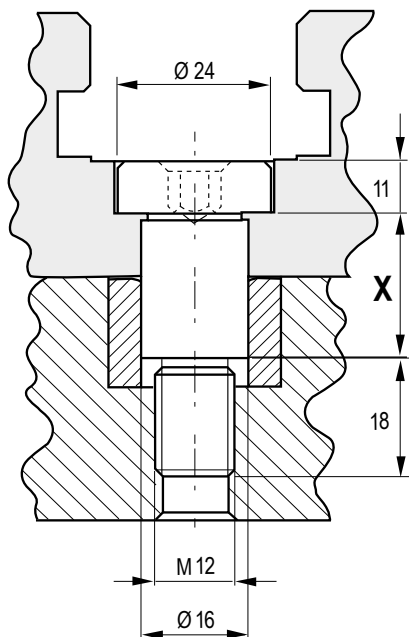
 Vite calibrata a colletto  
Shoulder calibrated screw

30	60	8.83.16300
35	70	8.83.16350
40	80	8.83.16400
45	90	8.83.16450
50	90	8.83.16500
55	100	8.83.16550
60	100	8.83.16600
65	110	8.83.16650
70	120	8.83.16700
75	130	8.83.16750
80	140	8.83.16800
85	150	8.83.16850
90	160	8.83.16900
95	170	8.83.16950
100	180	8.83.16100

**Art.83B**

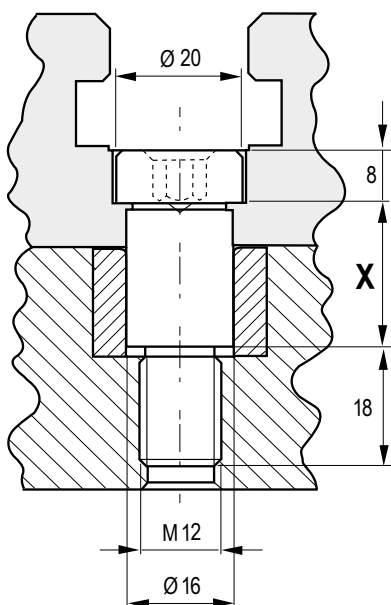
 Vite calibrata a colletto  
Shoulder calibrated screw

20	50	8.83.B1620
25	50	8.83.B1625
30	60	8.83.B1630
35	60	8.83.B1635
40	70	8.83.B1640
45	80	8.83.B1645
50	90	8.83.B1650
55	90	8.83.B1655
60	100	8.83.B1660
65	110	8.83.B1665
70	120	8.83.B1670
75	130	8.83.B1675
80	140	8.83.B1680
85	150	8.83.B1685
90	160	8.83.B1690
95	170	8.83.B1695
100	180	8.83.B1610

# BULLONERIA VARIA

## BUSHINGS AND BOLTS

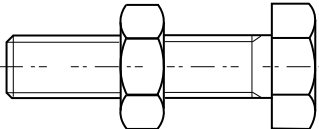
Dimensioni mm / Dimensions mm	Peso gr Weight	Cod.
<b>Art.83C</b>		
Vite riscontro Bolt travel limit		
		
M10 x 50		8.83C.413010
M10 x 60		8.83C.413020
M12 x 50		8.83C.513010
M12 x 60		8.83C.513020

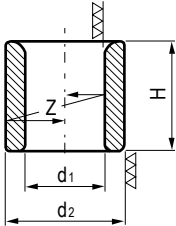
Dimensioni mm / Dimensions mm	d2	H	Z	Cod.
<b>Art.83D</b>				
Bussole di centraggio in acciaio speciale cementato HRc60. DIN 179C - 12 / 16 / 20 mm				
Centering bushing are in special alloy steel case hardened and heat treated hardness HRc60. DIN 179C - 12 / 16 / 20 mm				
				
12F7	18n6	12	0,01	8.83.D0000/12
16F7	26n6	16	0,01	8.83.D0000/16
20F7	30n6	20	0,01	8.83.D0000/20

Dimensioni mm / Dimensions mm	Cod.
<b>Art.83E</b>	
Filetti riportati in acciaio INOX M10 / M12 / M16	
M10 / M12 / M16 stainless steel helicoil	
	
	8.83.E0000/10
	8.83.E0000/12
	8.83.E0000/16

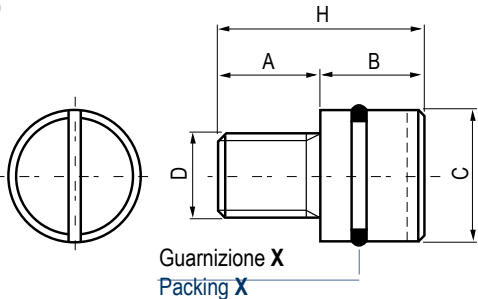
Dimensioni mm / Dimensions mm	A	B	C	D	H	X	Cod.
<b>Art.84</b>							
Tappi di chiusura (Alluminio)							
Plug (Aluminium)							
							
	10	11	12	M10	21	OR.108	8.84.403010
	15	16	16	M12	31	OR.3043	8.84.503010
	15	19	20	M16	34	OR.119	8.84.603010

# PORTAPEZZI MODULARI - STAFFE INTELLIGENTI

## MODULAR PIECE-HOLDERS - INTELLIGENT CLAMPS

Dimensioni mm / Dimensions mm		A	B	C	D	Cod.
<b>Art. 100</b>		80	100	16	16	8.10.08010
		100	100	20	20	8.10.01010
		100	120	20	20	8.10.01012

**Staffe intelligenti**  
Intelligent clamp

**Dolci o temprate**  
Soft or hardened

*A richiesta anche speciali / On request taylor made*

PRIGIONIERO - STUD		E	F	G	H	J	K	M	Cod.
<b>Art. 101</b>	<b>Dadi e rondelle inclusi</b> Including washer and nuts	16	80	30	30	20	6	16	8.10.12080
		20	100	35	40	25	6	20	8.10.12410
		20	120	40	50	30	6	24	8.10.13012

**Prigioniero**  
Stud

*A richiesta anche speciali / On request taylor made*

**Art. 376** in dotazione / Standard equipment

- Un primo lato del particolare da lavorare deve prima essere finito e predisposto per adattarsi alle staffe G.i. Normalmente si devono realizzare fori di precisione con filetto finale che servono per il posizionamento e l'ancoraggio superiore delle staffe G.i.
- Ancoraggio inferiore delle staffe G.i. sulla Vostra tavola a reticolo, oppure tramite una piastra a reticolo di interfacciamento se la Vostra tavola non può adattarsi alle staffe G.i.

**1-** The first face of the work piece must be finished to fit the new G.i. clamps. This means to make precision holes with a bottom thread which is used to fix the upper part of the G.i. clamps.

**2-** Fix the lower part of the G.i. clamps to the modular grid table or to another modular grid plate for interfacing with the normal table.

**Art. 101**  
Prigionieri calibrati  
Calibrated studs

**Art. 101**  
Prigionieri calibrati  
Calibrated studs

**Art. 101**  
Prigionieri calibrati  
Calibrated studs

**Art. 101**  
Prigionieri calibrati  
Calibrated studs

# FASI DI LAVORAZIONI CON LE STAFFE INTELLIGENTI Gi

## WORK CYCLE OPERATIONS WITH INTELLIGENT CLAMPS Gi



# 1

Lavorazione della prima faccia del pezzo grezzo e realizzazione delle sedi dei prigionieri con intassi simili al vostro piano a reticolo

First face of the rough workpiece must be finished including precision holes with bottom thread with same pitch of your grid plate for placing stud

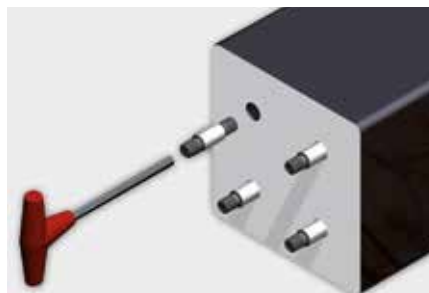

# 2

Inserire i prigionieri nella faccia del pezzo lavorato

Place the studs in the finished face



# 3

Fissare le staffe G.i. sul piano a reticolo per mezzo dei prigionieri

Fix the G.i. clamps on the grid plate through the studs

Dadi e rondelle  
Washer and nuts

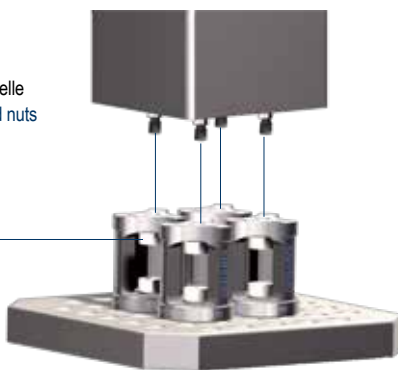

# 4

Sollevarlo il pezzo con inseriti i prigionieri e fissarlo sulle staffe G.i. tramite i dadi

Lift the workpiece with the studs in position and fixed to the G.i. clamps through the nuts



# 5

Ora il pezzo è fissato e posizionato

Now the workpiece is fixed and positioned the nuts

- Minimo ingombro e peso praticamente nullo ! Sistema semplificato al massimo !
- 5 lati liberi da lavorare senza alcun ingombro - Il percorso dell'utensile è libero e senza alcun intoppo
- Precisione di posizionamento facile e sicuro senza alcuna possibilità di spostamento in qualsiasi condizione di lavoro. Ripetibilità entro 0,02mm
- Semplicità, notevole risparmio di tempo e rapidità di staffaggio e posizionamento contemporanei
- Ammortamento praticamente immediato per i costi delle nuove staffe intelligenti G.i.
- Utilizzabili subito su qualsiasi Vs. tavola a reticolo oppure usando piastre di interfacciamento a reticolo se la Vs. tavola a cave non può adattarsi alle staffe G.i.
- Innalzamento automatico del Vs. pallet per centri di lavoro orizzontali che normalmente necessitano di una sovravola per sfruttare a pieno la corsa verticale del mandrino
- Disponibili sia dolci che temprate

- A simple system - Light weight - Minimum overall dimensions
- 5 free faces of the work piece can be machined without interference and the cutting tool can travel freely
- Easy, safe rigid and very accurate workpiece holding repeatability within 0,02mm.
- High time saving with simultaneous and simple workpiece positioning and clamping
- Cost quickly recovered in time saving
- Readily useable on grid tables or plates or using extra interface plates to the machine table
- Raises the work piece without the need for an extra over table. Thus allowing full utilization of the machine spindle vertical travel
- G.i. clamps available soft or hardened

